



International

Product Catalogue

2016-17

Contents

One system, two solutions	4
Pyronix Cloud & HomeControl+	6
Software	9
Control panels	13
Two-way wireless technology	13
PCX46 APP panel	15
Enforcer 32WE APP panel	18
Communication modems	21
HomeControlSIM	21
Input and output expanders	22
Arming devices	24
UR2 universal receiver	26
V2 speech diallers	27
Two-way wireless devices	30
Internal detectors	33
Dual technology internal detectors	34
Wireless internal detectors	38
Wired internal detectors	40
External detectors	47
Wireless external detectors	49
Wired external detectors	51
Sounders	55
External sounders	57
Internal sounders	58

New for this edition

HomeControl+ APP	6
PCX46 APP	16
Enforcer-32 APP	18
HomeControlSIM	21
UR2 universal receiver	26
External detectors	47



About us

Founded in 1986 in the UK, Pyronix is a world-leading manufacturer of intruder prevention equipment for use in residential, commercial and industrial applications.

Pyronix' focus on engineering excellence and cutting-edge design has helped the company reach a market-leading position within the UK. The company ensures its unrelenting success by continuously introducing new products to their already extensive range, such as the award-winning Enforcer two-way wireless technology, the XD external range of detectors and the PCX hybrid control panels.

Pyronix is at the forefront of the industry in introducing new platforms and software options to the market. These technologies aim to greatly enhance the experience of both the installer and user alike and started with the PyronixCloud and a whole host of IP communicators.

Being one of the foremost companies to offer an advanced user experience, with remote control of the security system from anywhere in the world, through the HomeControl+ App, Pyronix continue to add more features. HD WiFi cameras provide live video streaming and monitoring options, while wired-in programmable automation outputs enable the user to control garage doors or gates.

Pyronix continues to invest in certifying its products to the latest EN50131 standards and supporting an ambitious programme of developing the next generation of products.

In 2015, a multi-million pound investment culminated in the opening of a brand new state-of-the-art manufacturing facility in the UK. This facility maintains the company's ability to meet the ever-increasing demand for its products.

In May 2016, this privately owned company became a part of the largest supplier of surveillance equipment in the world, Hikvision. This China-based giant immediately invested in adding more resources to the Pyronix R&D team and in developing an aggressive strategy to considerably expand the Pyronix product range and strengthen its worldwide market position. One of the key elements of this strategy will be the long-established brand association with engineering excellence, high performance, innovation and accessibility.

Pyronix has always been devoted to strengthening partnerships and developing innovative ways of supplying the best possible solutions to meet their customers' needs and this is a trend that they remain firmly committed to.

[Find out more](#)



One system, two solutions

The Pyronix range of control panels offer multiple solutions for the protection of residential and small to medium commercial premises. The range consists of a wireless all-in-one control panel, the Enforcer 32WE APP, and two hybrid control panels, the PCX46S APP and PCX46L APP.

Wireless solution

The Enforcer 32WE APP is approved to EN50131 Grade 2 and is suitable for residential installations. While the Enforcer 32WE APP starts with 32 wireless and 3 wired inputs, it can be expanded to add a further 32 wired inputs.

Hybrid solution

There are 2 control panels in the PCX46 hybrid range:

- PCX46S APP approved to EN50131 Grade 2
- PCX46L APP approved to EN50131 Grade 3

Both panels are suitable for small to medium commercial installations. These systems start with 8 wired inputs, and can be increased to a possible 46 using our wired and wireless expansion modules.

Common programming and peripherals

The control panels all share the same wired and wireless peripherals, communication modules, remote programming software and cloud applications.

The same programming menu structure and diagnostic tools provide uniformed working across the range, which maximises usability and convenience for the installer.

Enforcer two-way wireless technology

Both solutions benefit from the use of the multi-award winning Enforcer two-way wireless protocol and a whole host of wireless peripherals. This includes PIR's and dual technology detectors, transmitters, safety sensors, sirens, arming devices and detectors for external protection.

Our Enforcer two-way wireless protocol has taken wireless protection to a new level; providing a truly high security, wireless solution.

Communication & app compatibility

Both solutions use the same communication options. They are also fully compatible with the great user and installer features offered by the PyronixCloud infrastructure:

- Remotely control multiple systems
- Receive both push and the new innovative voice alarm notifications
- Live streaming from up to 8 WiFi video cameras
- Fully compatible with iOS and Android devices

Remote diagnostic programs

Locally or remotely diagnose, maintain and program systems using the free UDL InSite and the PyronixCloud infrastructure.

These applications can be used via any of the IP communication modules, such as DIGI-GPRS, DIGI-LAN and DIGI-WIFI.

DIGI-GPRS & roaming SIM

The DIGI-GPRS modem supports IP and SMS communications. This modem is fully roaming and when used together with the Pyronix HomeControl roaming SIM, offers the best out-of-the-box, secure and flexible plug-and-play communication solution.

The SIM will automatically connect to the best network available and covers most European counties.

The service is activated through the PyronixCloud and includes one-year unlimited data usage when used with Pyronix control panels. It also supports SMS messaging.

ARC communications

Both solutions support Contact ID IP and SIA Level 3 IP and are capable of sending alarm events to monitoring stations.

The free Pyronix ENIP server software provides a secure link between control panels and monitoring stations.

This software must be used to receive events and can be interfaced with any modern alarm receiving software via standard automation protocols.

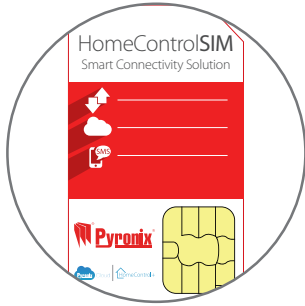

HomeControlSIM



PyronixCloud

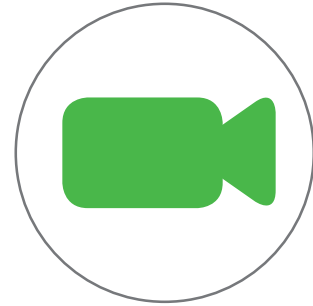

HomeControl+ Cameras



Enforcer 32WE APP



HomeControl+ APP



PCX46S APP / PCX46L APP



Two-way wireless accessories



Pyronix Cloud



PyronixCloud.com

The PyronixCloud acts as a gateway between the Pyronix IP control panels, the HomeControl+ App and the UDL InSite software.

Fully Encrypted System

The connections to and from the PyronixCloud are fully encrypted to ensure all messages, including push notifications, are safely and securely transmitted.

Remote monitoring tools & account controls

The PyronixCloud provides excellent tools for installers and monitoring stations, who offer monitoring and maintenance services to their customers. The PyronixCloud infrastructure allows the account holder to add and remove app users and manage the type of push notifications sent.

Online administration software

Hosted with Amazon Web Services, utilising load balance technology and health monitoring, the PyronixCloud acts as the online administration software for connected Pyronix IP control panels.

App Customisation

With the PyronixCloud, installers can fully personalise their apps by adding their logo to the HomeControl+ App homepage. The additional branding delivers maximum brand exposure while enhancing customer experience.

See it in action



HomeControl+ App

HomeControl+ gives users unprecedented access and visibility over their home and business systems, from anywhere in the world. It allows end users to arm and disarm their system, get push notifications to their Android or iOS smart devices when events occur, receive customised notifications and check the status of each individual sensor.

The HomeControl+ App supports the innovative new voice push notification feature, which sends a voice notification directly to the user's smartphone. This ensures the user is alerted if their alarm is triggered.

HomeControl+ is compatible with the Enforcer 32WE APP and PCX46 APP panels and is available on Android and iOS devices.



HomeControl+ App

Users can download the Pyronix HomeControl+ App from the Apple App store or Google Play store and connect to their Pyronix app-enabled control panels and video cameras.

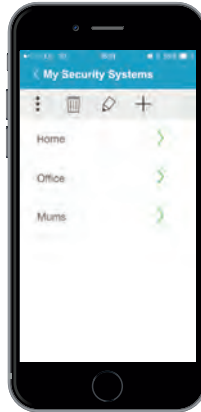

My security system

Multiple systems can be accessed through the HomeControl+ App. The user can add, delete, edit and connect to the system, change settings and view notifications.

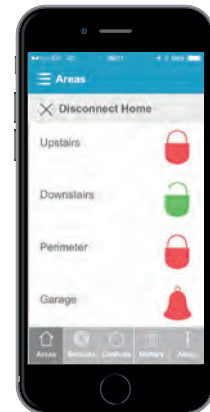

Areas

Users can view area status in real-time and arm or disarm them from anywhere in the world. Simple locked and unlocked padlocks indicate the status, while a bell indicates if the system is in alarm.

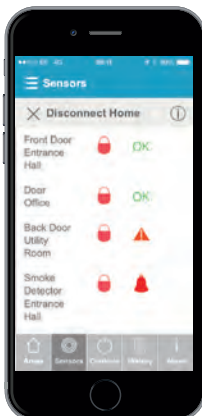

Sensors

The user can view the status of the sensors on the system, whether they are armed or disarmed in real time, see which sensor has gone into alarm, view sensor faults or even bypass them.

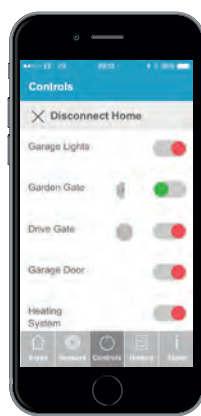

Controls

The status of automation outputs can be viewed in real-time, allowing unprecedented control over a variety of appliances such as: lighting, shutters, garage doors and more.



My video

Users can check on their home from anywhere in the world, viewing their property through up to eight WiFi cameras.





SOFTWARE

Alarm and technical fault monitoring

The Pyronix ENIP Server software acts as an IP receiver designed to interface the Pyronix IP control panels with the monitoring software of the Alarm Receiving Centre (ARC) via a standard automation protocol.

The MX-MON monitoring software provides the installer with a flexible start up alarm monitoring solution or technical faults monitoring service centre.



ENIP Server

The Pyronix ENIP server software is used to create an IP receiver that will act as a gateway between the Pyronix IP control panels and the Alarm Receiving Centre (ARC) monitoring software.

IP Protocol: The European TS IP protocol approved by CENELEC is used for alarm transmission CLC/ TS 50131-9: 2013 Part 9.

ATS Security Level: The IP protocol is specified to ATS level SP5.
DIGI-GPRS and DIGI-LAN: SP5-ITSEC-01/15

Encryption: All communications are encrypted to the highest standard.

Registration module

This module is used to register the Pyronix IP control panels onto the Pyronix EN IP server.

The security initial key exchange is created either automatically or manually.

Programmable polling frequency

Automation server module

This module enables the connection of the Pyronix ENIP server to the software used by the monitoring station for managing alarms.

The IP server can output events to automation/central station management software over a serial port or LAN connection using Surgard, Ademco 685 and Silent Knight protocols.

An important factor of this system is that it manages LAN and GPRS channels.

Using the hardware suggested, the installer can connect up to 5,000 alarm control panels to a Pyronix ENIP Server if the polling frequency was set to 5min.

For a simple start up, the Pyronix IP Server can be installed on a single basic PC (laptop).



Minimum recommended requirements

Minimum hardware requirements:

- Intel or AMD 2Ghz Processor or greater
- 2GB RAM
- 100MB Hard Disk Space

Minimum requirement for the operating system:

- Microsoft Windows 7 Professional/Ultimate 32 or 64-bit (ask Pyronix for 64-bit support version if required)
- An open internet connection
- Fixed IP address on internet connection
- Administrative rights on the PC
- Microsoft SQL Server Express 2008 or later (free download from Microsoft)
- USB Port for software protection dongle

NOTE: We do not recommend Windows 8

Optional operating system requirements:

- Microsoft SQL Server 2008 or later (this is the full version, and not free)
- Microsoft Windows 7 Professional/Ultimate, 64 bit (ask Pyronix for 64 bit version of software if required)
- Microsoft Windows Server 2012
- GSM/GPRS modem for sending SMS messages, software supports Siemens TC35/MC35.
- 4GB RAM if using 64-bit or Microsoft SQL Server
- Suitable backup device such as; tape, CD/DVD Writer or USB Drive (highly desirable)
- We also recommend that the PC is used for the sole purpose of running the IP Server.
- The IP Server can be run on a virtual PC provided it has access to a USB port (in this instance the installer could run the software on multiple server hardware to limit the impact of a hardware failure).
- If the IP Server PC is behind a router/firewall then port forwarding may be required either on the router or by using port forwarding software.



MX-MON monitoring software

MX-MON is monitoring software designed for start-up Monitoring Stations (ARC), who wish to receive technical fault events. The software can be interfaced to the Pyronix ENIP software and telephone digital receivers.

- Choice of Access or SQL databases
- Networkable with an unlimited number of operators
- Flexible report creating feature
- Programmable dedicated event resolution keys from F1-F12
- Programmable levels of access for each operator
- Programmable audible alarms for each event group
- Programmable expected open/close schedule per account
- Up to 9 levels of maps per account
- Supports SK Extended, Surgard, Ademco 685 and Pyronix protocols.
- FREE upgrades
- The MX-MON software is protected by a USB dongle key

The MX-MON can be downloaded from the following link:
www.pyronix.com/download-mxmon.php

CONTROL PANELS

PCX46 and Enforcer control panels and peripherals

The hybrid PCX46 range of control panels are suitable for small and medium commercial applications and are approved to EN50131 for Grade 2 (PCX46S APP) and 3 (PCX46L APP) installations.

The all-in-one wireless Enforcer 32WE APP control panel is suitable for residential applications and is approved to EN50131 for Grade 2 installations.

Both systems are PyronixCloud and HomeControl+ App compatible; combining excellent functionality with easy installation and great diagnostic features.

The multi-award winning Enforcer two-way wireless technology delivers the convenience and ease of installation of a wireless system, without compromising on the reliability or security benefits of a wired system.



Two-way wireless technology

No mess, no fuss, simply excellent performance

The multi-award winning Enforcer two-way wireless technology delivers the convenience and ease of installation of a wireless system, without compromising on the reliability or security benefits of a wired system.

Real-time two-way device control

Each device on the system is both a transmitter and a receiver. This ensures that messages such as arming, disarming, alarm, tamper or supervision, have been received by each device on the system in real-time.

Multi-event transmission

All wireless peripherals know when the control panel is armed or disarmed. When the system is armed and an alarm is activated, the motion detectors do not disable, so that each new activation is transmitted to the ARC or user.

Prolonged battery life

When the system is disarmed all detector functions, besides two-way supervision, enter sleep mode to save battery life.

Jamming detection

Jamming detection is used to prevent accidental or deliberate attempts to disrupt the system.

Dead spot reduction with dual antennas

Dual antennas both transmit signals to help reduce 'dead spots'. This provides maximum stability of the system over a longer period of time.

Easy installation with Signal Strength Indicators (SSI)

Signal Strength Indicators (SSI) allow the installer to verify the quality of the signal received by the device, in real-time. Because the SSI is displayed on the device installation time is significantly reduced, as the installer does not have to keep referring back to the panel.

Two-way wireless keyfobs

Two-way wireless keyfobs indicate when the system is armed, disarmed or in alarm and can also control automation outputs.

Secured with 128-bit encryption

128-bit encryption provides effective protection of signals being transmitted by the system and prevents code-grabbing. This gives the wireless BUS a very high level of protection, ensuring peace of mind for both installers and users alike.

Longer range 1.6km in open space

The high sensitivity receiver allows a wireless signal range of up to 1.6km in open space, eliminating the need for repeaters and reducing installation costs.



Hybrid control panels

There are 2 control panels in the PCX46 hybrid range:

- PCX46S APP approved to EN50131 Grade 2
- PCX46L APP approved to EN50131 Grade 3

Both panels are suitable for small to medium commercial installations.

Up to 46 wired and wireless peripherals

Using the wired and wireless input expanders the PCX panels can support up to 46 inputs. This provides the installer the flexibility to add additional internal and external sensors to the system.

High security Enforcer two-way wireless

The wireless expander (PCX RIX32-WE) uses the highly secure Enforcer two-way wireless protocol, which supports up to 32 wireless devices, 32 keyfobs, 4 arming stations and 2 wireless sirens. This means that installers can seamlessly add wireless internal and external detectors, shock sensors and safety sensors to the system.

Up to 46 wired inputs with triple EOL wiring capability

The wired input expanders support inertia and roller shutter sensors, as well as high end anti-masking detectors, via the triple EOL wiring capability.

Common housing for a unified look

The common housing throughout our wired and two-way wireless peripherals ensure aesthetic consistency, should the installer decide to create a hybrid system.

Communications, diagnostics & app compatibility

Using IP modems such as the DIGI-LAN, DIGI-WIFI or DIGI-GPRS, the PCX range is fully compatible with the PyronixCloud, HomeControl+ App, ENIP server and UDL InSite software. This enables controls, ARC connections and remote diagnostics of the system.

The PCX control panels also support the DIGI-PSTN modem, which can be used as a second path communicator.

Automation outputs

The PCX range supports up to 30 wired automation outputs to give the user control of garage doors, gates or shutters for example. These can be controlled via the HomeControl+ App, keyfob or wired and wireless keypad.

PCX46 APP hybrid system architecture

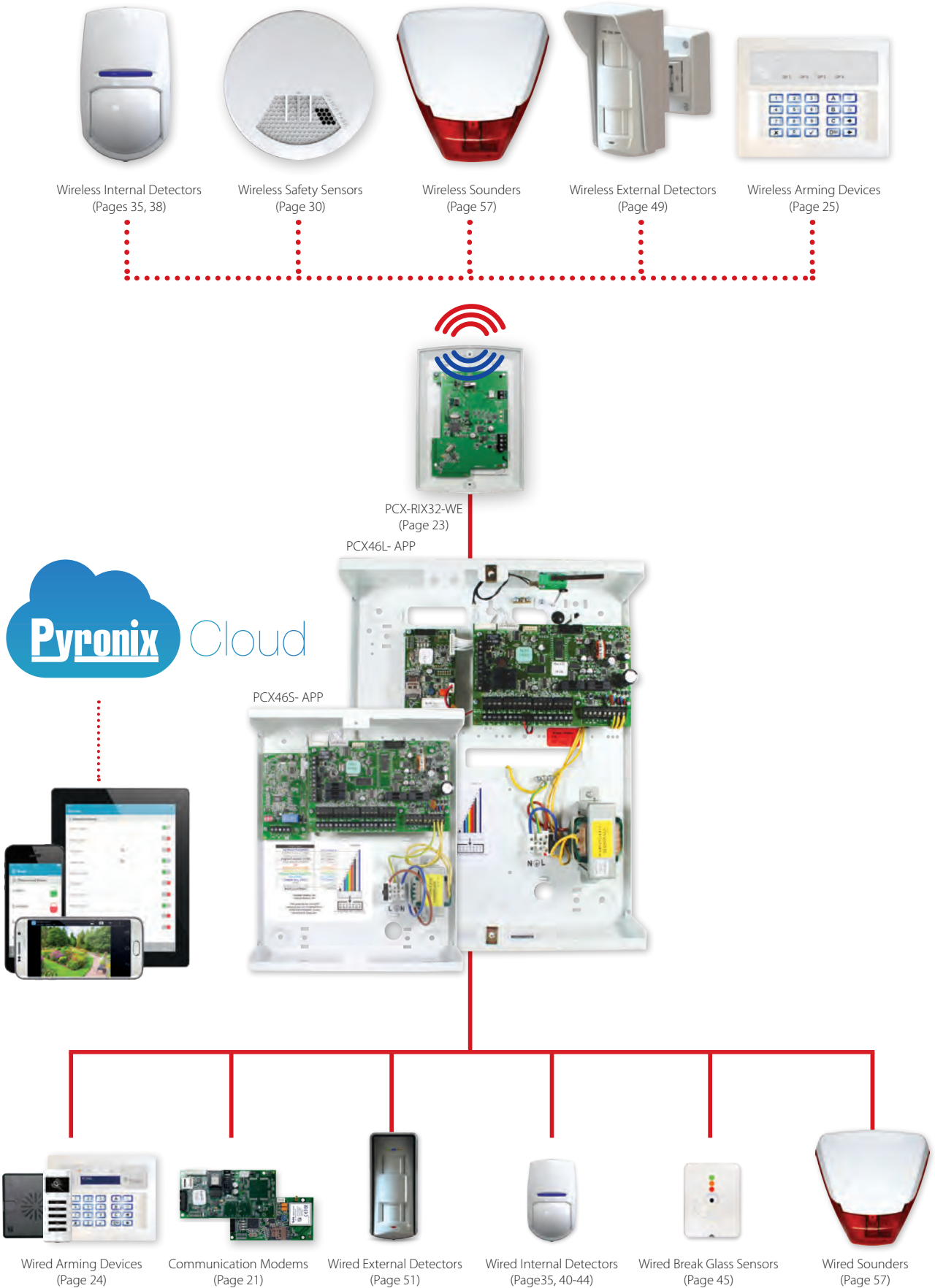

PCX46 hybrid control panels

Integrated hybrid control panels with Enforcer two-way wireless technology



PCX46S APP



PCX46L APP

PCX kit contents

	Small	Large
Metal casing with tamper protection		
PCX46-APP PCB	✓	✓
Power transformer	✓	✓
Keypad	Sold separately (page 24)	Sold separately (page 24)
Communication modem	Sold separately (page 21)	Sold separately (page 21)

Key features

Independent areas	8	8
Wired inputs (NC/DEOL/3-EOL)	8 expandable to 46	8 expandable to 46
Two-way wireless inputs	32	32
Outputs on board	3 expandable to 50	3 expandable to 50
ATE outputs on board	0 expandable to 8 relay with ATE8R Module	0 expandable to 8 relay with ATE8R Module
Automation outputs	30	30
Two-way wireless keyfobs	32	32
User codes and prox tags	100	100
Guard codes	20	20
Two-way wireless sounders	2	2
Integrated power supply	1.5A	2A
Phone numbers for SMS notification	10	10
SMS remote control app compatibility	✓	✓
Reporting formats	SIA 3 IP, Contact ID IP, SIA 3, Contact ID	
Supported modems	DIGI-GPRS, DIGI-LAN, DIGI-PSTN (sold separately)	
Compatibility with HomeControl+ App	✓	✓

Technical specifications

Internal power supply	1.5A	2A
Power supply	110-230 DC / 50-60 Hz	110-230 DC / 50-60 Hz
Current consumption	80mA	80mA
AUX output voltage	9 - 16 DC (12 DC normal)	9 - 16 DC (12 DC normal)
Programmable outputs	3A, Max 30V relay	3A, Max 30V relay
Siren and strobe output	500mA	500mA
Input resistors	1k at rest 2k in alarm <1k>2k in tamper	1k at rest 2k in alarm <1k>2k in tamper
Battery capacity	7Ah	7Ah - 17Ah
AUX fuse	800mA	800mA
Siren fuse	800mA	800mA

Other details

Operating storage temperature	-10°C / +50°C -20°C / +60°C	-10°C / +50°C -20°C / +60°C
Dimensions	250 x 297 x 82mm	390 x 305 x 100mm
Weight	3.6 kg without battery	5.6 kg without battery
Warranty	2 years	2 years

Certifications

Electrical conformity	CE	CE
EN50131	Grade 2	Grade 3
Environmental class	II	II
	CA12.01494	CA12.01494

*smartphone not included



Two-way wireless control panel

Ideal for any residential application

Communication between the HomeControl+ App and Enforcer 32WE APP panel is encrypted to the highest standards, ensuring that sensitive information is secured and safe from accidental or malicious attacks.

A truly high security, wireless solution.

The Enforcer 32WE APP all-in-one wireless control panel takes residential security to a new level. The introduction of our Enforcer two-way wireless protocol offers a truly high security, wireless solution.

Up to 32 wireless inputs

The Enforcer control panel supports 32 wireless inputs, 4 arming stations, 32 keyfobs and 2 wireless sirens.

The extensive range of wireless peripherals available include: internal and external detectors, magnetic contacts, shock sensors, safety sensors and wireless arming devices.

Multi-event transmission

All wireless peripherals know when the control panel is armed or disarmed. When the system is armed and an alarm is activated, unlike other wireless detectors, our motion detectors do not disable immediately, so that each new activation is transmitted to the ARC or user.

Up to 32 wired inputs

The Enforcer 32WE APP also supports wired inputs including wired keypads and proximity readers. The 2 on-board inputs and 3 outputs can be expanded to a maximum of 32 wired inputs and 16 wired outputs, using the integrated RS485 bus.

Communications, diagnostics & app compatibility

Using IP modems such as the DIGI-LAN, DIGI-WIFI or DIGI-GPRS, the Enforcer 32WE APP is fully compatible with the PyronixCloud, HomeControl+ App, ENIP server and UDL InSite software. This enables controls, ARC connections and remote diagnostics of the system.

Home Automation outputs

The Enforcer 32WE APP supports up to 19 wired automation outputs to give the user control of garage doors, gates or shutters for example. These can be controlled via the HomeControl+ App, keyfob or wired and wireless keypad.

Enforcer system architecture



Control your security system from your smartphone or tablet with the HomeControl+ APP

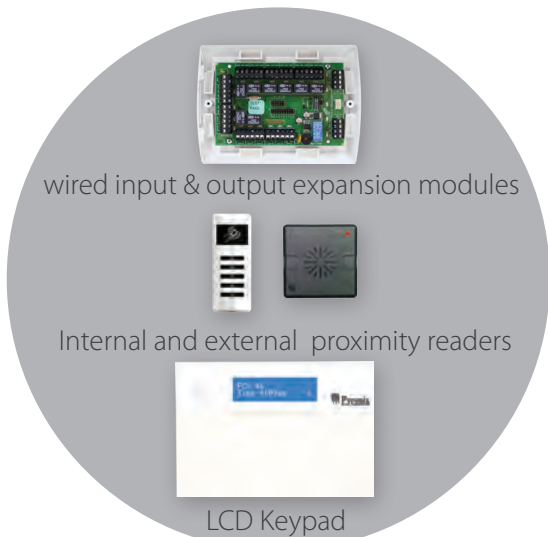

Wired Accessories



Enforcer two-way wireless control panel



KIT-ENF32WE-AM[†]

KIT-ENF32WE-AM/GPRS[†]

Kit contents

Enforcer 32WE APP two-way wireless control panel	1	1
Two-way wireless quad PIR detector, KX12DQ-WE	1	1
Two-way wireless magnetic contact, MC1 MINI-WE	1	1
Two-way wireless keyfob, KF4-WE, with 4 keys and 8 functions	1	1
GPRS and SMS modem, DIGI-GPRS	x	1
Proximity tag, PCX-PTAG	1	1

Key features

Two-way wireless inputs	32	32
Wired inputs	3 expandable to 34	3 expandable to 34
Total inputs	66	66
Wired outputs	2 expandable to 38	2 expandable to 38
Encryption type (panel to peripherals)	128 bit Encryption	128 bit Encryption
Encryption type (App communications)	AES 256 bit Encryption	AES 256 bit Encryption
Two-way wireless keyfobs	32	32
Two-way wireless sounders	2	2
User codes	75	75
SMS numbers	10	10
Integrated power supply	0.7A	0.7A
Independent areas	4	4
Tamper protection	Front and back	Front and back
Remote diagnostics	✓	✓
HomeControl+ App compatibility	Android v4.1 and above and iOS v7.0	Android v4.1 and above and iOS v7.0
Supported modems = DIGI-GPRS, DIGI-WIFI, DIGI-LAN (sold separately)	✓	✓

Electrical specifications

Internal power supply	1A	1A
Power supply	110-230 AC / 50-60 Hz	110-230 AC / 50-60 Hz
AUX output voltage	9-16DC (12DC nominal)	9-16DC (12DC nominal)
Current consumption	75mA in rest / 220mA in alarm	75mA in rest / 220mA in alarm
Programmable outputs	350mA	350mA
Input resistors	1k in rest 2k in alarm <1k>2k in tamper	1k in rest 2k in alarm <1k>2k in tamper
Backup battery (included)	BATTENF8XAA - 9v, 2.1A	BATTENF8XAA - 9v, 2.1A
AUX fuse	500mA	500mA
Siren and strobe output	350mA	350mA

Other details

Operating storage temperature	-10°C/+50°C -20°C/+70°C	-10°C/+50°C -20°C/+70°C
Weight	1025g	1025g
Dimensions	220 x 160 x 50 (mm)	220 x 160 x 50 (mm)
Warranty	2 years	2 years

Certifications

Electrical conformity	CE	CE
EN50131	Grade 2	Grade 2
Environmental class	II	II
	CA12.01328	CA12.01328

Accessories



BATT-ENF8XAA Battery for the Enforcer 2.1A



PCX-PTAG Proximity tag for the Enforcer and PCX (5pcs)



RS232 Programming cable

[†]Kit contents and language may vary locally.
^{††}smartphone not included

Communication modems

Communication modems for the Enforcer and PCX



DIGI-LAN



DIGI-GPRS



DIGI-WIFI



DIGI-GSM



DIGI-1200 (PSTN)

Compatibility

HomeControl+ App	✓	✓	✓	✗	✗
------------------	---	---	---	---	---

Key

Formats	Contact ID IP, SIA3 IP, supports uploading/downloading	Contact ID IP, SIA3 IP, SMS, supports uploading/downloading	Contact ID IP, SIA 3 IP, supports uploading/downloading	Contact ID, SMS	Contact ID
Voltage	+12VDC	+12VDC	+12VDC	+12VDC	+12VDC
Dimensions	109 x 56 x 14 mm	110 x 56 x 10 mm	109 x 56 x 11 mm	110 x 56 x 10 mm	110 x 56 x 10 mm
Roaming capabilities	✗	✓	✗	✗	✗
Warranty	2 years	2 years	2 years	2 years	2 years

Certifications

Electrical conformity	CE	CE	CE	CE	CE
ATS	SP5	SP5	SP5	SP2	SP2
Environmental class	II	II	II	II	II

Accessories



AERLEAD1-10

Adapter for the antenna MMCX to SMA - JW / K 20cm (10 pack)

HomeControlSIM*

The HomeControlSIM is a roaming data and SMS service offered by Pyronix. Active in most of Europe** the SIM, together with the DIGI-GPRS, automatically connects to the best GPRS network available. As a result, it provides a universal and safe communication solution to users and installers alike. With unlimited data when used with Pyronix devices, the HomeControlSIM is a yearly subscription service that can also support an optional SMS service.

What are the advantages?

- The roaming service works with all operators.
- Easy to install and maintain because it is independent of the local network.
- High security connection without compromising any local network Firewall.
- One service that allows all the following at the same time:

End user: control your system remotely with the HomeControl+ App.

Installer: remote maintenance with the UDL Insite software.

Alarm Receiving Centre (ARC): event communications to the ARC.

- Complete and total independence from the router and ADSL service.

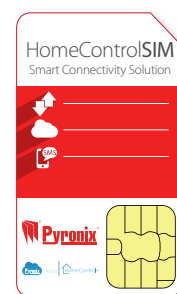

HomeControlSIM*

Compatibility

HomeControl+ App	✓
------------------	---

Key features

Unlimited data when used with Pyronix Products	1 year
Send SMS†	✓

*Coming Soon. **Available in Austria, Belgium, Bulgaria, Croatia, Cyprus, Czech Republic, Denmark, Finland, France, Germany, Greece, Hungary, Iceland, Ireland, Italy, Latvia, Lithuania, Luxembourg, Malta, Netherlands, Norway, Poland, Portugal, Romania, Slovakia, Slovenia, Spain, Sweden & Switzerland. †SMS purchasable through the PyronixCloud.



Input and output expanders

Input and output expansion modules for the Enforcer and PCX





PCX-RIX8i-P/BOX



PCX-RIX8+P/BOX



PCX-RIX8+PSU-M/BOX

Type of module	PCX-RIX8i-P/BOX	PCX-RIX8+P/BOX	PCX-RIX8+PSU-M/BOX
Wired input expander module	✓	✓	✓
Two-way wireless expander module	✗	✗	✗
Output expander module	✗	✗	✗
Key features			
Wired inputs (NC/DEOL/3-EOL)	8 [†]	8	8
Inertia and roller shutter sensors support	8	✗	✗
Output support	✗	4 Open Collector	4 Open Collector
Two-way wireless inputs	✗	✗	✗
Two-way wireless keyfobs	✗	✗	✗
Two-way wireless sirens	✗	✗	✗
Housing with tamper protection	Plastic	Plastic	Metal
Integrated power supply	✗	✗	2.5A
Power input	9 -15 DC	9 -15 DC	220-240 AC
Other details			
Operating storage temperature	-10°C to +50°C -20°C to +60°C	-10°C to +50°C -20°C to +60°C	-10°C to +50°C -20°C to +60°C
Weight	500g	500g	5.6kg
Dimensions	173 x 125 x 32mm	173 x 125 x 32mm	225 x 150 x 30mm
Warranty	2 years	2 years	2 years
Certifications			
Electrical conformity	CE	CE	CE
EN50131	Grade 2	Grade 3	Grade 3
Environmental class	II	II	II
	CA12.01433	CA12.01434	CA12.01431
	✗	✗	✗

[†]Not compatible with 3-EOL inputs



PCX-ATE8R*



PCX-RIX32-WE*



PCX-ROX8R8T-P/BOX



PCX-ROX16R-PSU-M/BOX

x	x	x	x
x	✓	x	x
✓	x	✓	✓
x	x	x	x
x	x	x	x
8 Relays	x	8 Open Collector / 8 Relays	16 Relays
x	32	x	x
x	32	x	x
x	2	x	x
x	Plastic	Plastic	Metal
x	x	x	2.5A
9 - 15 DC	9 - 15 DC	9 - 15 DC	220-240 AC
-10°C to +50°C -20°C to +60°C	-10°C to +50°C -20°C to +60°C	-10°C to +50°C -20°C to +60°C	-10°C to +50°C -20°C to +60°C
68g	1.07kg	315g	5kg
109 x 56 x 14mm	173 x 125 x 32mm	173 x 125 x 32mm	225 x 150 x 30mm
2 years	2 years	2 years	2 years
CE	CE	CE	CE
Grade 3	Grade 2	Grade 3	Grade 3
II	II	II	II
x	CA12.01439	CA12.01435	CA12.01432
Self-certified	x	x	x

*Only compatible with PCX control panels

Wired arming devices

Wired arming devices for the Enforcer and PCX control panels



Features

	PCX-LCDP	PCX-LCDP/W	PCX-PROXI/EX	PCX-EXT-BK	PCX-EXT-W
LCD Keypad	ABS plastic	Painted white finish	x	x	x
Surface mounted	✓	✓	✓	✓	✓
Flush mount back box available	x	✓	x	x	x
Interchangeable keypad casings	x	✓	x	x	x
Integrated prox reader	✓	✓	✓	✓	✓
Internal-use prox reader	✓	✓	✓	x	x
IP65 rated external-use prox reader	x	x	x	✓	✓
On-board inputs	2	2	2	1	1
On-board outputs	1	1	1	1	1



Electrical specifications

	PCX-LCDP	PCX-LCDP/W	PCX-PROXI/EX	PCX-EXT-BK	PCX-EXT-W
Power supply	12VDC (9-15v DC)	12VDC (9-15v DC)	12VDC (9-15v DC)	12VDC (9-15v DC)	12VDC (9-15v DC)
Current consumption	50mA	50mA	30mA	22mA	22mA
Inputs	2EOL, 3EOL	2EOL, 3EOL	2EOL	2EOL	2EOL
Outputs	100mA	100mA	150mA	150mA	150mA

Other details

	PCX-LCDP	PCX-LCDP/W	PCX-PROXI/EX	PCX-EXT-BK	PCX-EXT-W
Operating storage temperature	-10°C/+40°C -20°C/+60°C	-10°C/+40°C -20°C/+60°C	-10°C/+40°C -20°C/+60°C	-20°C/+60°C -20°C/+60°C	-20°C/+60°C -20°C/+60°C
Weight	258g	258g	130g	220g	220g
Dimensions	114 x 99 x 34mm	160 x 126 x 30mm	97 x 40 x 23mm	85 x 85 x 21mm	85 x 85 x 21mm
Warranty	2 years	2 years	2 years	2 years	2 years

Certifications

	PCX-LCDP	PCX-LCDP/W	PCX-PROXI/EX	PCX-EXT-BK	PCX-EXT-W
Electrical conformity	CE	CE	CE	CE	CE
EN50131	Grade 3	Grade 3	Grade 3	Grade 3	Grade 3
Environmental class	II	II	II	IV	IV
	CA12.01424	Self-certified	CA12.01420	CA12.01419	CA12.01419
	IMQ Test House	Self-certified	IMQ Test House	IMQ Test House	IMQ Test House

Accessories

	PCX-PTAG	Proximity tag for the Enforcer and PCX (5pcs)		LCD-CASING/SCHROME	Satin chrome casing for the PCX-LCDP/W
	RS232	Cable used for local programming via the RS232 output		LCD-CASING/CHROME	Shiny chrome casing for the PCX-LCDP/W
	AERLEAD1-10	Adapter to the antenna MMCX-JW a SMA/K 20cm. (10pcs)		LCD-CASING/BCHROME	Brushed chrome casing for the PCX-LCDP/W
	LCD-FLUSHBOX	Flushmount adapter for the PCX-LCDP/W		LCD-CASING/BLACK	Black casing for the PCX-LCDP/W
	LCD-CASING/GOLD	Gold casing for the PCX-LCDP/W		SCN-PCX/BLACK	Black screen for the PCX-LCDP/W (10pcs)



Wireless arming devices

Wireless arming devices for the Enforcer and PCX control panels



KF4-WE

Key features

4 button with 8 button functions	✓
System status display	✓
Arm one or all areas per button	✓
Disarm one or all areas per button	✓
Hold-up function	✓
Activate output automation	✓
Lock and unlock buttons	✓

Electrical specifications

Transmission frequency	868MHz, FM transceiver
Transmission method	128bit encrypted radio protocol
Range in open space	300m
3v lithium battery included	BATT-CR/KF1
Minimum battery life (years)	1

Weight and dimensions

Weight	28g
Dimensions	72 x 30 x 20mm
Warranty	2 years

Certifications

Electrical conformity	CE
EN50131	Grade 2
Environmental class	II
	CA12.01329



LEDRKP/WHITE-WE

Technical characteristics

Plastic keypad with LED icon display	✓
Integrated prox reader	✓
Entry and exit tones	✓
Backlit keys	✓
Dedicated keys for automation output control	4
3V / 5A Lithium battery included	BATT-ES1
Signal Strength indicators (SSI)	✓

Certifications and warranty

Electrical conformity	CE
EN50131	Grade 2
Environmental class	II
Self-certified	Self-certified
Warranty	2 years

Accessories



BATT-CR/KF1

3V Battery for KF4-WE MK II



PCX-PTAG

5x Proximity tags for the Enforcer and PCX



BATT-ES1

2x Lithium batteries. Used with Deltabell-WE, XD wireless detectors and Keypad, 3v, 5Ah

UR2-WE universal receiver



Connect any control panel with the Enforcer two-way wireless devices



Compatible with
ANY BRAND[†]
of alarm control panel
([†]with arm and disarm outputs)

The UR2-WE allows installers to use Enforcer two-way wireless peripherals on any brand of alarm control panel with arm and disarm outputs.

This wireless expander gives the ability to add up to 10 wireless sensors or 6 wireless keyfobs per channel, giving the install all the great benefits of the multi-award winning Enforcer two-way wireless range.



UR2-WE



KIT XDH10TT1-WE

Key features	
Alarm relay output for each wireless channel	2
Wireless channels	2*
Two-way wireless detectors	10 per channel
Two-way wireless keyfobs	6 per channel
Wireless peripherals dedicated fault relay	1
System ARM / DISARM input	1
Alarm indication (7 segment display)	1
Electrical specifications	
Power supply	9 - 15 DC
Current consumption	Min 80mA / max 400mA
Relay x 3	3A
Other details	
Operating storage temperature	-10 / +50 -40 / +70
Dimensions	173 x 125 x 32mm
Warranty	2 years
Certifications	
Electrical conformity	CE
Environmental class	II

XDH10TT-WE	2
UR2-WE	1

*Each channel can either support keyfobs or detectors not a mixture.



V2 speech diallers

Universal speech diallers



V2GSM



V2TEL

Features	GSM	PSTN
Dialler	GSM	PSTN
Key features		
Inputs	6 expandable to 14	6
Outputs	4 expandable to 52	4
Voice messages	Up to 14	6
SMS messages	Up to 14	x
Telephone numbers	9	9
Duplex	Full	Half
Integrated microphone and speaker	✓	✓
Integrated keypad	✓	✓
Remote control via a telephone	✓	✓
Automatic phone number recognition (CLIP)	✓	x
Can be used as a telephone	✓	✓
Date and time stamp	✓	x
Event log	256	30
Anti-jamming feature	✓	x
Operating temperature	-20°C to +40°C	-20°C to +40°C
Dimensions	147 x 100 x 28mm	147 x 100 x 28mm
Power supply	10-14DC	10-14DC
Current consumption	300mA Max (40mA at rest)	300mA Max (40mA at rest)
Warranty	2 years	2 years
Certifications		
Electrical conformity	CE	CE



WIRELESS PERIPHERALS

Enforcer two-way wireless peripherals

Enforcer two-way wireless technology is designed to ensure high security protection for users, with simple installation and maintenance for the installer.

Each safety and security device is both a transmitter and a receiver. This provides real-time status readings at both the control panel and the wireless device.

The range includes a large number of peripherals that utilise our highly secure Enforcer two-way wireless technology. This allows installers to create the perfect security solution for any residential or commercial building.



Enforcer two-way wireless safety sensors



WL-WE

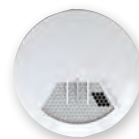

SMOKE-WE



CO-WE

Sensor types

Water leak sensor with 1m cable included	✓	✗	✗
Smoke detector	✗	✓	✗
Carbon monoxide detector	✗	✗	✓

Key features

Button sensor test	✗	✓	✓
LED sensor test	✗	✓	✓
Front and rear tamper protection	✓	✓	✓
3V lithium battery included	1 x CR2	1x CR123A	✗
1.5V alkaline battery included	✗	✗	3x AA
Signal Strength Indicators (SSI)	✓	✓	✓
Minimum battery life (years)	2	2	1
Warranty	2 years	2 years	2 years

Certifications

Electrical conformity	CE	CE	CE
EN50131	n/a	n/a	n/a
Environmental class	II	n/a	n/a
Self-certified	n/a	n/a	n/a
Specialist certification	✗	EN 14604:2005+AC:2008	EN50291-1:2010

Accessories



BATT-CR2

Replacement 3V lithium battery CR2 for the WL-WE



BATT-CR123A

Replacement 3V lithium battery CR123A for SMOKE-WE

Enforcer two-way wireless magnetic contacts and shock sensors



	MC1MINI-WE	MC1/SHOCK-WE	MC2-WE	RS2-WE
Inputs				
Magnetic contact plug and play	✓	✗	✗	✗
Shock sensor and magnetic contact / universal transmitter with 2 wireless channels	✗	✓	✗	✗
Magnetic contact and one channel universal transmitter	✗	✗	✓	✗
Magnetic contact and Roller shutter support / 2 channel universal transmitter	✗	✗	✗	✓
Key features				
Terminal for N/C input and reed switch	✗	✓	✓	✓
Tamper input	✗	✓	✓	✓
Front and rear tamper protection	✓	✓	✓	✓
Signal Strength Indicators (SSI)	✓	✓	✓	✓
Magnet included	✓	✓	✓	✓
Electrical specifications				
Transmission frequency	868MHz, FM transceiver			
Transmission method	128bit encrypted radio protocol			
Range in open space	1600m			
3V lithium battery included	1 x CR123A	1 x CR123A	1 x CR2	1 x CR2
Minimum battery life (years)	2	2	2	2
Warranty	2 years	2 years	2 years	2 years
Certifications				
Electrical conformity	CE	CE	CE	CE
EN50131	Grade 2	Grade 2	Grade 2	Grade 2
Environmental class	II	II	II	II
	CA12.01482	Self-certified	CA12.01326	Self-certified
	IMQ Test House	Self-certified	IMQ Test House	Self-certified

Accessories

	BATT-CR123A	Replacement 3V lithium battery CR123A for MC1/SHOCK-WE and MC1MINI-WE		BATT-CR2	Replacement 3V lithium battery CR2 for the transmitters
	MC1MINI-SPACER	White spacer* kit for the MC1MINI-WE		MC1MINI-SPACERBR	Brown spacer* kit for the MC1MINI-WE
	MC1S/SPACER	White spacer* kit for the MC1/SHOCK-WE		MC1S/SPACERBR	Brown spacer* kit for the MC1/SHOCKBR-WE
	MC-BROWN-KIT	Brown plastics kit for MC1-WE, MC2-WE, RS1-WE, RS2-WE.		MC1MINIBR-KIT	Brown 10x fronts and 10x backs for MC1MINI-WE
	MC1/SHOCKBR-KIT	Brown 10x fronts and 10x backs for MC1/SHOCK-WE		MAGNETBR-KIT	Brown 20x magnet plastics kit

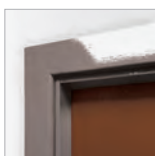

* The spacer allows for the magnetic contact to be installed on an uneven or misaligned door or window frame.



INTERNAL DETECTORS

Wired and two-way wireless grade 2 and 3 internal detectors

An extensive range of internal detectors utilising the latest Pyronix patented technologies for residential, commercial and light industrial use.

The KX range of Passive Infrared Detectors (PIRs) are ideal for residential installs, delivering detection up to 30m, animal immunity up to 25kg, auto sensitivity and more. There is also the compact pet immune Colt which has an unobtrusive style or the Break-Glass detector which monitors your windows. Any combination of these can cover lounges, kitchens, bedrooms, extended corridors, bedroom areas and more.

For light industrial and commercial use there is our KX Dual Technology range. As both sensors need to be triggered to sound the alarm, these are perfect for harsher environments, such as mechanics workshops, aisles or storage facilities. The range also includes fantastic anti-blocking and anti-mask variant for Grade 3 installs.



KX Internal dual technology detectors

Dual technology

Dual technology improves the reliability of the detectors as, to get an alarm condition, both PIR and Microwave technologies have to be activated simultaneously, thus increasing stability in hostile environments.

Blue Wave Technology

Safeguards against false alarms and improving immunity to interference through advanced signal processing and 3D optics.

Digital temperature compensation

Digital temperature compensation digitally adjusts the sensitivity of the detectors, maintaining the detectors specified range when the background temperature is near to body temperature.

Anti-cloaking technology

AND/OR anti-cloaking technology gives priority to the microwave sensor under certain conditions, such as an intruder wearing clothing with infrared cloaking properties, maintaining performance.*

Independent Floating Thresholds

IFT technology (Independent Floating Thresholds) ensures that the alarm thresholds are always kept within predetermined limits, eliminating electrical environmental disturbances.

Automatic sensitivity

The detector is able to self-adapt to changing environmental conditions, ensuring stability and intruder catch performance is maintained.

Anti-masking (anti-spray)

Adjustable anti-masking technology offers unique protection against attempts to mask the PIR or microwave and detects masking with a variety of materials, such as, cardboard, duct tape, spray, lacquer or aluminium foil.*

DEOL resistors

On board DEOL resistors reduce installation time. The range of values covers the majority of systems.*

Different microwave frequencies

Avoids interference (cross-talk) that can occur when two detectors with microwave modules in them are installed within close proximity of each other. This optimises detector stability.

Anti-blocking technology

Any attempt to block the field of view is detected. This allows the detector to send a signal to the panel to inform it that the detection area is being blocked, and must be removed before the system is set.*

*Wired dual technology KX detectors only

KX internal dual technology detectors



KX12DT-WE KX10DTP-WE KX15DTAM KX15DT KX10DTP

	KX12DT-WE	KX10DTP-WE	KX15DTAM	KX15DT	KX10DTP
Coverage	Volumetric	Volumetric	Volumetric, Curtain, Long range	Volumetric	Volumetric
Maximum range	12m	10m	15m/18m/30m	15m	10m
Optimal installation height	1.8-2.4m	1.8-2.4m	1.8-2.4m	1.8-2.4m	1.8-2.4m
Creep-zone protection	✓	✗	✓	✓	✗
Key features					
Adjustable anti-masking (anti-spray)	✗	✗	✓	✗	✗
Anti blocking technology	✗	✗	✓	✗	✗
Animal immune	✗	Up to 24kg	✗	✗	Up to 24kg
Blue Wave Technology	✓	✓	✓	✓	✓
Automatic sensitivity	✓	✓	✓	✓	✓
Digital temperature compensation	✓	✓	✓	✓	✓
Anti-cloaking technology	✗	✗	Anti-Blocking	And/or	And/or
Separate indication: microwave, PIR and alarm	✓	✓	✓	✓	✓
3 microwave frequencies to avoid interference	✓	✓	✓	✓	✓
DEOL resistors on board	✗	✗	✓	✓	✓
Tamper protection included	✓	✓	✓	✓	✓
Signal Strength Indicators (SSI)	✓	✓	n/a	n/a	n/a
Wired					
Power supply	-	-	9-16 DC (12DC nominal)		
Current consumption at rest	-	-	23mA		
Current consumption in alarm	-	-	30mA		
Relay type	-	-	Solid state		
Output relay	-	-	60DC, 50mA protection		
Tamper terminal	-	-	12DC max, 50mA max		
Wireless electrical specifications					
Transmission frequency	868MHz, FM transceiver		-		
Transmission method	128bit encrypted radio protocol		-		
Range in open space	1600m		-		
3V lithium battery included	2x CR123A		-		
Minimum battery life (years)	2		-		
Electrical specifications					
RFI immunity from continuous wave (CW), modulated wave (AM) and pulse (PM) 80-2700MHz	25 V/m		25 V/m		
Microwave frequency	10.515, 10.525, 10.535GHz		10.515, 10.525, 10.535GHz		
Alarm response	-		2.5 second		
Detection speed	0.3 - 3m/s		0.3 - 3m/s		
Direct light filter	>6500 Lux		6500 Lux		
Optics	Sealed		Sealed		
Geometric lens configuration	3D		3D		
Other details					
Operating storage temperature	-10°C / +40°C -20°C / +50°C		-30°C / 50°C -40°C / 70°C		
Weight	135g		125g		
Dimensions	117x69x59mm		117 x 69 x 55 mm		
Warranty	2 years		5 years		
Accessories					
Wall/ceiling brackets included (KXBRACKET-C, KXBRACKET-W)	Sold separately	Sold separately	✓	✓	✓
Long range and curtain lenses included (KX30-LR e KX18-LC)	Sold separately	Sold separately	✓	✗	✗
Bracket back tamper kit included	✗	✗	✓	✗	✗
Certification					
Electrical conformity	CE	CE	CE	CE	CE
EN50131	Grade 2	Grade 2	Grade 3	Grade 2	Grade 2
Environmental class	II	II	II	II	II
	CA12.01483	CA12.01484	CA12.01176	CA12.01175	CA12.01425

KX internal dual technology detectors

Lens diagrams

KX12DT-WE

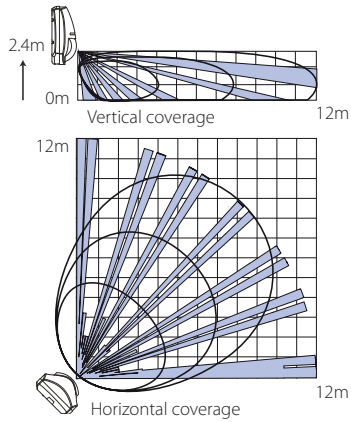

KX10DTP-WE & KX10DTP

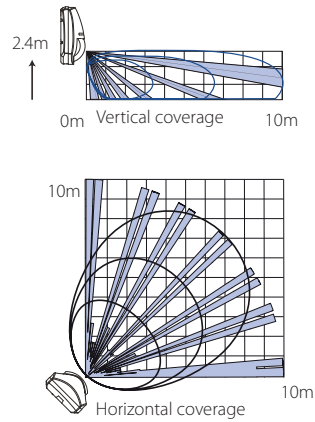

KX15DT - KX15DTAM

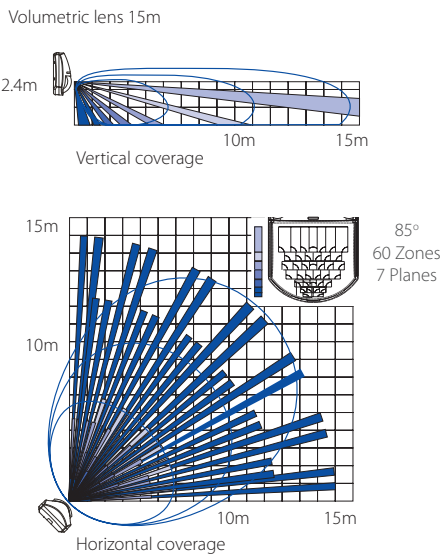

KX15DTAM long range

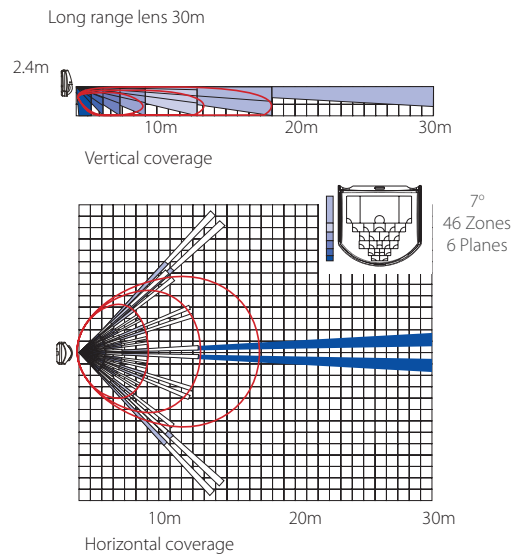



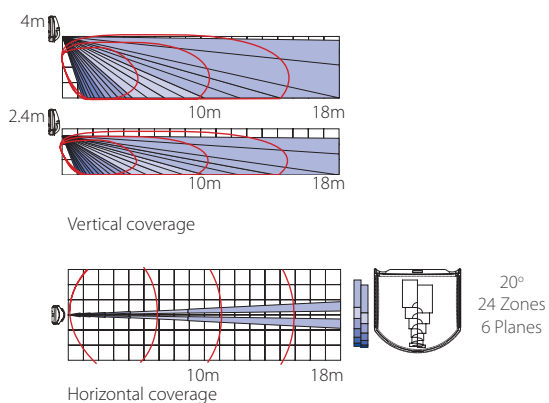

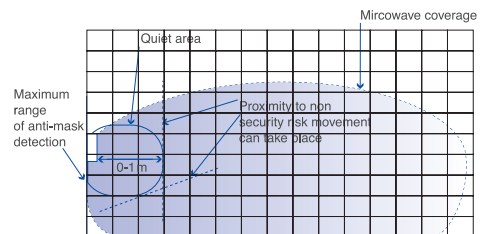

KX15DTAM



Anti-Masking



Accessories

	KXBRACKET-C	Ceiling bracket for the KX range (10pcs)		KX15-VL	Replacement volumetric lens for KX 15m (3pcs)
	KXBRACKET-W	Wall bracket for the KX range (10pcs)		KX-TAMPER	Tamper kit for the KX brackets (10pcs)
	KX30-LR	Replacement long range lens for KX 30m (3pcs)		BATT-CR123A	Replacement 3V lithium battery CR123A



KX internal PIR range detectors

Blue Wave Technology

Safeguards against false alarms and improving immunity to interference through advanced signal processing and 3D optics.

Digital temperature compensation

Digital temperature compensation digitally adjusts the sensitivity of the detectors, maintaining the detectors specified range when the background temperature is near to body temperature.

Optical 3D system

Allows for better focussing of areas to improve the detection of moving targets and ensure more precise signals can be received from the PIR. The 3D system also allows protects of the area below the detector (creep zone).

Independent Floating Thresholds

IFT technology (Independent Floating Thresholds) ensures that the alarm thresholds are always kept within predetermined limits, eliminating electrical environmental disturbances.

Automatic sensitivity

The detector is able to self-adapt to changing environmental conditions, ensuring stability and intruder catch performance is maintained.

DEOL resistors

On board DEOL resistors reduce installation time. The range of values covers the majority of systems.*

3mm ABS plastics

Detector housings are consistent throughout the range of KX detectors and ensure great resistance to environmental factors to maintain consistent performance over long periods of time.

Ceiling mount technology

Combines a quad interlocking sensor and the 360 degree optical system, to provide large volumetric coverage at all installation heights up to 4m.

*Wired KX detectors only

Enforcer two-way wireless KX detectors



Two-way wireless movement sensors



KX25LR-WE



KX15DC-WE



KX10DP-WE



KX12DQ-WE

Lens characteristics

Volumetric lens 85 degree coverage, 7 planes, 60 zones	×	×	✓	✓
Pet immunity coverage, 6 planes, 56 zones	×	×	✓	×
Curtain lens, 20 degree coverage, 6 planes, 46 zones	×	✓	×	×
Long range lens, 20 degree coverage, 6 planes, 24 zones	✓	×	×	×
Maximum range	25m	15m	10m	12m
Optimum installation height	1.8-2.4m	Max 4m	1.8-2.4m	1.8-2.4m
Creep-zone protection	✓	✓	×	✓

Key features

Animal immunity	×	×	25kg	×
Blue Wave technology	✓	✓	✓	✓
Automatic sensitivity	✓	✓	✓	✓
Automatic temperature compensation	✓	✓	✓	✓
Front and rear tamper protection included	✓	✓	✓	✓
Signal Strength Indicators (SSI)	✓	✓	✓	✓

Electrical specifications

Transmission frequency	868MHz, FM transceiver			
Transmission method	128bit encrypted radio protocol			
Range in open space	1600m			
3V lithium battery included	1x CR123A	1x CR123A	1x CR123A	1x CR123A
Minimum battery life (years)	2	2	2	2







Other details

Operating storage temperature	-10°C /+40°C -20°C /+50°C			
Weight	125g			
Dimensions	117 x 69 x 50mm			
Warranty	2 years			

Certifications

Electrical conformity	CE	CE	CE	CE
EN50131	Grade 2	Grade 2	Grade 2	Grade 2
Environmental class	II	II	II	II
	CA12.01428	CA12.01427	CA12.01426	CA12.01325

Accessories

	KXBRACKET-C	Ceiling bracket for the KX range (10pcs)		KX30-LR	Replacement long range lens for KX 30m (3pcs)
	KXBRACKET-W	Wall bracket for the KX range (10pcs)		KX15-VL	Replacement volumetric lens for KX 15m (3pcs)
	KX18-LC	Replacement curtain lens for KX 18m (3pcs)		BATT-CR123A	Replacement 3V lithium battery CR123A

Enforcer two-way wireless KX detectors

Lens diagrams

KX10DP-WE

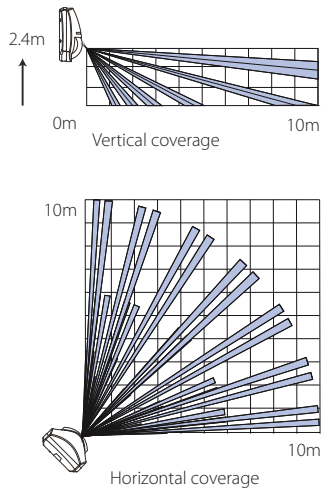

KX12DQ-WE

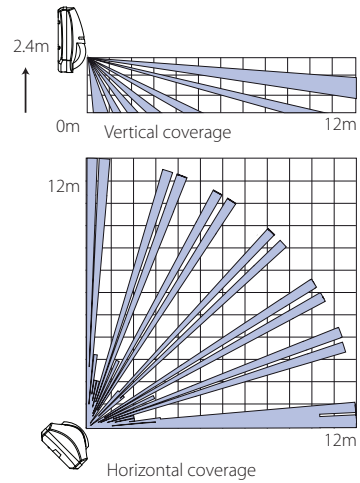

KX25LR-WE

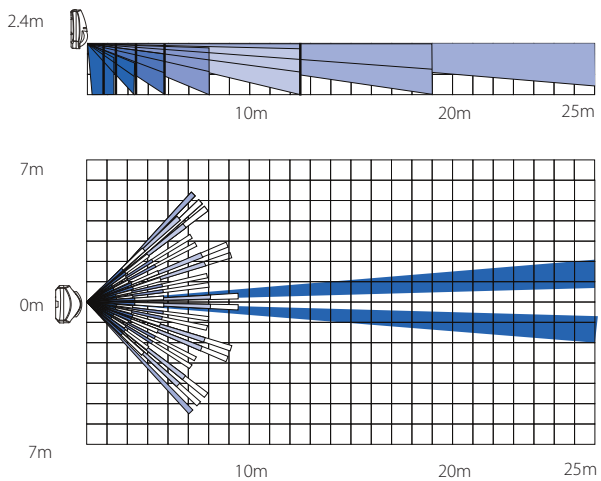

KX15DC-WE

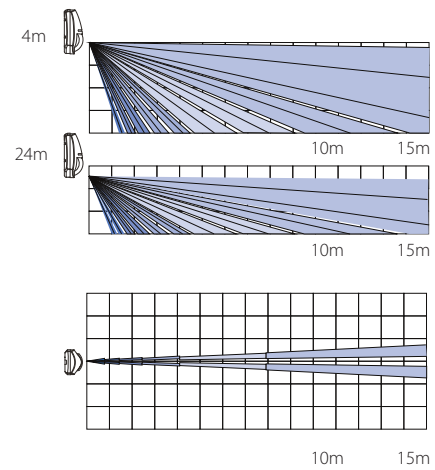

KX internal PIR range detectors



KX15DD

KX15DQ

KX10DP

KX18DC

Optical and range features

Volumetric coverage: 85 degree, 7 planes, 60 zones	✓	✓	✗	✗
Pet detection: 85 degree, 6 planes, 56 zones	✗	✗	✓	✗
Curtain coverage: 20 degree, 6 planes, 46 zones	✗	✗	✗	✓
Long range coverage: 20 degree, 6 planes, 24 zones	✗	✗	✗	✓
Maximum range	15m	15m	10m	18m / 30m LR
Optimal installation height	1,8-2,4m	1,8-2,4m	1,8-2,4m	Max 4m / 1,8-2,4m
Creep-zone protection	✓	✓	✗	✓

Key features

Animal immune	✗	✗	24kg	✗
Blue Wave Technology	✓	✓	✓	✓
Automatic sensitivity	✗	✓	✓	✓
Digital temperature compensation	✓	✓	✓	✓
Optical quad	✗	✓	✗	✗
DEOL resistors on board	✓	✓	✓	✓
Tamper protection included	✓	✓	✓	✓

Electrical specifications

Power supply	9-16 DC (12DC nominal)
Current consumption at rest	11mA
Current consumption in alarm	13mA
Relay type	Solid state
Outputs relay	60DC, 50mA protection
Tamper terminal	12DC max, 50mA max
RFI immunity from continuous wave (CW), modulated wave (AM) and pulse (PM) 80-2700MHz	10 V/m
Alarm response	2.5 seconds
Detection speed	0.3 - 3m/s
Direct light filter	6500 Lux
Optics	Sealed optics
Geometric lens configuration	3D

Other details

Operating storage temperature	-30°C -50°C -40°C - 70°C
Weight	125g
Dimensions	117 x 69 x 55 mm
Warranty	5 years

Accessories

Ceiling bracket included, KXBRACKET-C	✓	✓	✓	✓
Wall bracket included, KXBRACKET-W	✓	✓	✓	✓
Additional long range lens included, KX30-LR	✗	✗	✗	✓

Certification and warranty

Electrical conformity	CE	CE	CE	CE
EN50131	Grade 2	Grade 2	Grade 2	Grade 2
Environmental class	II	II	II	II
	CA12.01171	CA12.01172	CA12.01173	CA12.01174

KX internal PIR range detectors

Lens diagrams

KX15DQ

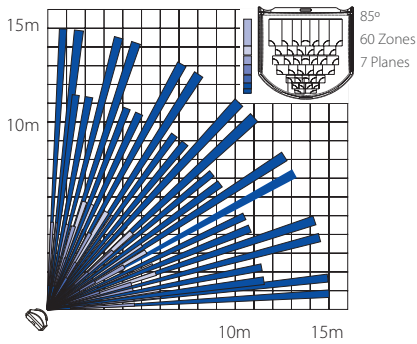
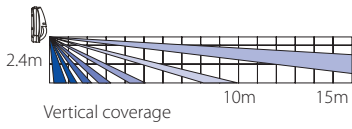

Lens: KX15VL

KX10DP

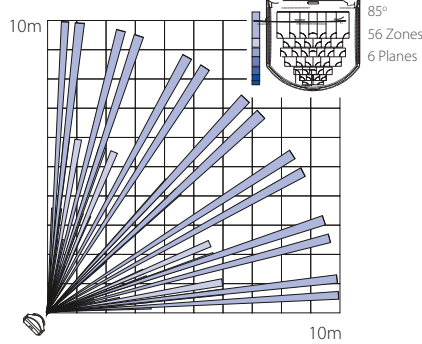
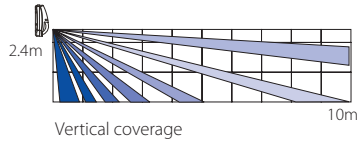

Lens: KX15VL

KX18DC Long Range

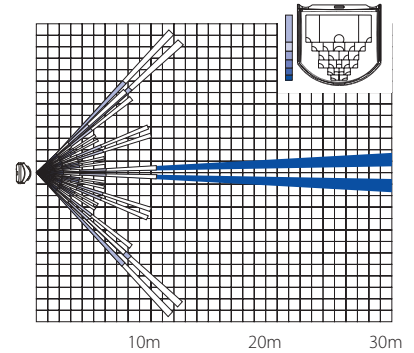
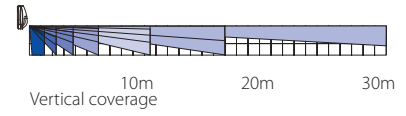

Lens: KX30LR

KX18DC (Vertical curtain)

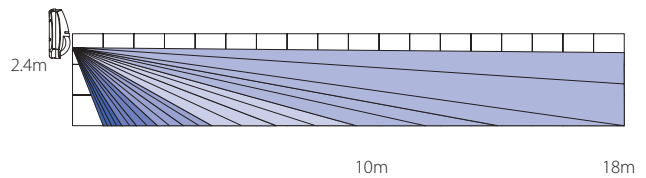
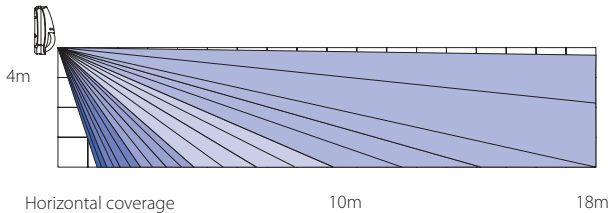
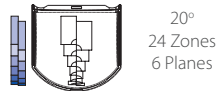
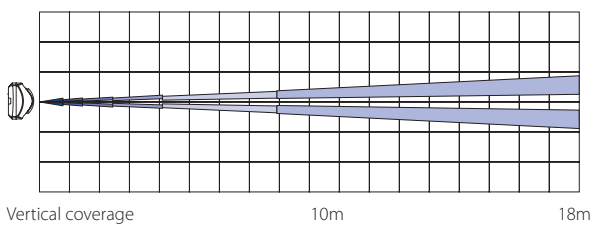

Accessories



KXBRACKET-C

Ceiling bracket for the KX range (10pcs)



KX30-LR

Replacement long range lens for KX 30m (3pcs)



KXBRACKET-W

Wall bracket for the KX range (10pcs)



KX15-VL

Replacement volumetric lens for KX 15m (3pcs)



KX18-LC

Replacement curtain lens for KX 18m (3pcs)



KX-TAMPER

Tamper kit for the KX brackets (10pcs)



Colt range



COLT10DL

Optical and range features

Volumetric coverage: 90 degree, 56 zone and 5 planes	✓
Maximum range	10m
Optimal installation height	1.8-2.4m

Key features

Animal immune	Up to 10kg
Digi logic technology	✓
Adjustable sensitivity	✓
Tamper protection	✓

Electrical features

Operating voltage	9 - 16 VDC
Quiescent current consumption	15mA at 12V
Relay outputs	SELV limits, 60Vdc, 50mA (42.4Vac peak)
Tamper switch	12V 50mA

Other details

Operating storage temperature	-30°C to 70°C -40°C to 80°C
Weight	58g
Dimensions	82 x 50 x 41mm
Warranty	5 years



Certifications

Electrical conformity	CE
EN50131	Grade 2
Environmental class	II
 Pyronix	Self-certified

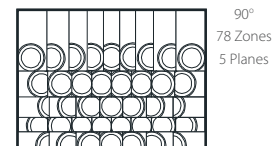
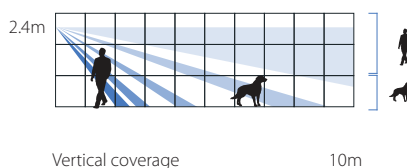
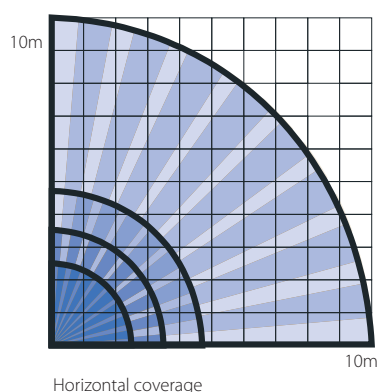
Lens diagrams



Accessories

	Lens 5	Replacement lens. 90 degree, 5 planes, 74 zones (3pcs)
	KXBRACKET-C	Ceiling bracket included, KXBRACKET-C (10pcs)
	KXBRACKET-W	Wall bracket included, KXBRACKET-W (10pcs)

Internal ceiling mount PIR detector - Octopus EP



OCTOPUS EP

Optical and range features

Volumetric coverage: 360 degree, 156 zone, 3 planes	✓
Maximum range	12m
Optimal installation height	2,4-4m
Ceiling mount PIR	✓

Key features

Quad-interlocking element pyroelectric sensor	✓
Independent Floating Threshold (IFT) technology	✓
Adjustable sensitivity	✓
Automatic temperature compensation	✓
Power supply	9-16DC (12DC nominal)
Relay type	Solid state
Outputs relay	60DC, 50mA protection
Tamper terminal	12DC max, 50mA max
RFI immunity from continuous wave (CW), modulated wave (AM) and pulse (PM) 80-2700MHz	10 V/m
Alarm response	2.5 seconds
Detection speed	0.3 - 3m/s
Geometric lens configuration	3D
Warranty	5 years

Certification

Electrical conformity	CE
EN50131	Grade 2
Environmental class	II
 Pyronix	Self-certified

Lens diagrams

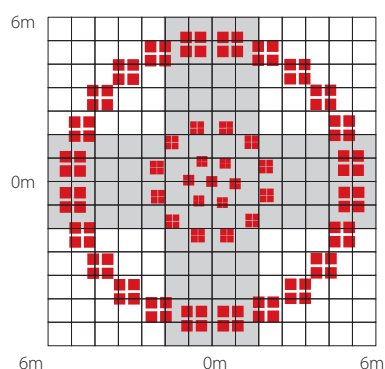

Vertical coverage

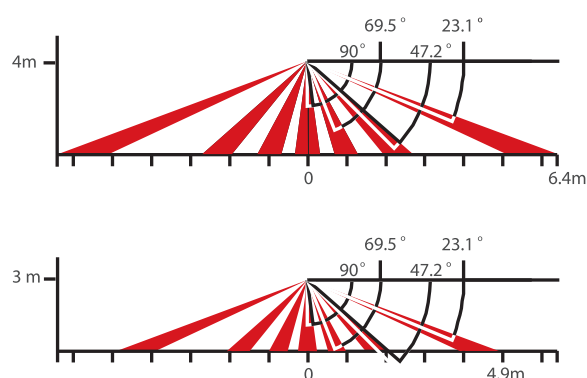

Horizontal coverage

Breakglass detectors



BG2000



BG16DF

Key features

Designed for most types of glass	✓	✓
Coverage diameter	8m	6m
Angle of coverage	360°	360°
Digital technology	✓	✓
Dual confirmation detection - first impact	✓	✓
Detects the frequency of glass flexing	✓	✓
Detects the frequency of glass breaking	✓	✓
Installation Test Mode	✓	✓
Option to Latch Alarm Relay	✓	✓

Electrical specifications

Power	9-16DC (12V nominal)	
Current consumption at rest	30mA (a 13.8V)	
Current consumption in alarm	28mA (a 13.8V)	
Outputs relay	60DC, 50mA protection	
Tamper terminal	12V max, 50mA max	
RFI immunity from continuous wave (CW), modulated wave (AM) and pulse (PM) 80-2700MHz	10 V/m	
Glass type	Float, piano, reinforced, laminated, leaded, double glazed	
Glass thickness	2.4mm to 6.4mm	
Glass dimensions	0.3m x 0.3m to 3m x 3m	
Alarm duration	2.5 seconds	
Detection speed	0.2 - 3m/s	
Installation height	2.4-8m	

Other details

Operating storage temperature	-10 - 50 -20 - 70	
Weight	100g	
Dimensions	90 x 90 x 30mm	
Warranty	2 years	

Certifications

Electrical conformity	CE	CE
-----------------------	----	----

Combination of both frequencies (Alarm)

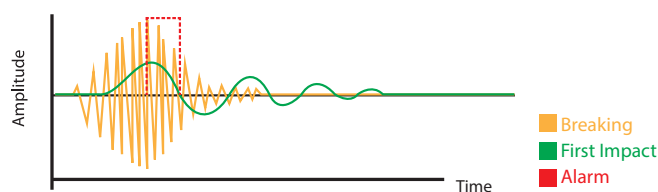

Breakglass tester

BG-TESTER

Key features

Reproduces the frequency of first impact	✓
Reproduces the frequency of glass flexing	✓
Reproduces the frequency of glass breaking	✓
Warranty	2 years

Certifications

Electrical conformity	CE
-----------------------	----





EXTERNAL DETECTORS

Wired and two-way wireless detectors for residential and commercial protection

There are two different options within the XD range: a high mount XDH for volumetric coverage and a low mount XDL for perimeter protection.

The detectors combine 1 microwave and 2 PIR sensors to ensure maximum stability in an external environment.

The wired XD detectors also utilise high security features such as anti-masking (anti-spray) and anti-blocking technology.

For ease of use, all detectors include a walk-test buzzer to ensure they have been correctly installed. On the wireless XD detectors this can be enabled by a switch on the detector or by activating walk-test mode on the control panel.



External detector technology

XDH detectors (H - high mount)

High mount detectors are designed to be installed at 2.4m. The optics of the XDH detectors are designed to give optimum volumetric coverage of the protected area, using 78 zones, 5 planes and 85 degree coverage.

XDL detectors (L - low mount)

Low mount detectors are designed to be installed at 1.2m. The optics of the XDL detectors are designed to give optimum curtain coverage of the protected area, using 6 zones, 1 plane and 14 degree coverage.

Triple technology detection

Helping to reduce false alarms by using a tri-signal detection logic, in which the alarm is only generated when the two PIR and microwave sensors are all activated in a given period of time.

Automatic sensitivity

The detector is able to self-adapt to changing environmental conditions, ensuring stability and intruder catch performance is maintained.

Digital temperature compensation

Digitally adjusts the sensitivity of the detectors, maintaining the specified range when the background temperature is near to body temperature.

Independent Floating Thresholds

IFT technology (Independent Floating Thresholds) ensures that the alarm thresholds are always kept within predetermined limits, eliminating electrical environmental disturbances.

Anti-blocking technology

Ensures that any attempt to block the field of view is detected. This allows the detector to send a signal to the panel, informing it that the detection area is being blocked.

DEOL resistors

On board DEOL resistors reduce installation time. The range of values covers the majority of systems.

Anti-masking (anti-spray)

Adjustable anti-masking technology offers unique protection against attempts to mask the PIR or microwave and detects masking with a variety of materials, such as, cardboard, duct tape, spray, lacquer or aluminium foil.*

Different microwave frequencies

Avoids interference (cross-talk) that can occur when two detectors with microwave modules in them are installed within close proximity of each other. This optimises detector stability.

Weatherproof technologies

Ensuring the detector is not affected by adverse weather conditions. These technologies employ the use of polycarbonate housing, sealed optics, humidity protection, as well as a heavy duty ultraviolet filter.

Vegetation sway elimination

Allowing the detector to distinguish between regular movement of trees and plants with the movements of an intruder to ensure maximum false alarm protection.

*Wired XD detectors only

Two-way wireless external detectors



XDH10TT-WE



XDL15TT-WE Coming Q1 2017

Features

Installation type	XDH	XDL
Optimal installation height	2.4m	1.2m
Coverage	Volumetric	Curtain
Maximum range	10m	15m
Animal immunity	10kg	25kg

Key features

Two-way wireless	✓
Tri-signal detection logic	2 x infrared + 1 x microwave
Automatic sensitivity	✓
Digital IFT technology	✓
Temperature compensation	Digital
3 LED indication for microwave, infrared and alarm	✓
3 different microwave frequencies	✓
Integrated walk test buzzer	✓
Tamper	✓

Electrical specifications

Transmission frequency	868MHz, FM Transceiver
Transmission method	128bit encrypted radio protocol
Range in open space	1600m
3V lithium battery included	2x 3V 5AHr (BATT-ES1)
Minimum battery life (years)	3
Plastic housing material	Polycarbonate
PCB	Anti-humidity
Optics	Sealed
Lens UV protection	UV Filter
Environmental protection grade	IP55

Other details

Operating storage temperature	-30°C/+55°C -40°C/+50°C
Weight	500g
Dimensions	180mm x 80mm x 105mm
Warranty	2 years







Accessories

2 flexible masking grids	✓	✗
2 fixed masking grids to create curtain protection	✓	✓

Certification

CE declaration	CE	CE
EN50131	Grade 2	Grade 2
Environmental class	IV	IV
	Self-certified	Self-certified

Accessories

	XD-WALLBRACKET	Adjustable wall bracket +/- 45 degrees with anti-tamper protection. This allows for better volumetric coverage.		BATT-ES1	2x Lithium batteries. Used with Deltabell-WE, XD wireless detectors and Keypad, 3v, 5Ah
	XD ADAPTER	45 degree adapter for use with the XD-WALLBRACKET. This allows the XD detectors to be positioned at 90 degrees to the wall for protection of walls.		XD-LENS 5	Volumetric lens for the XDH. Installation 2.4m, 85 Degrees, 10m detection distance. (3pcs)
	XD FIXEDBRACKET	Wall bracket with rear tamper. This can be used to create 30m coverage protection of external walls.		XD-LENS 4	Long range lens for the XDL series of detectors. 14 degree coverage, 6 zone edges, 1 plane. (3pcs)

Wireless coverage patterns and features

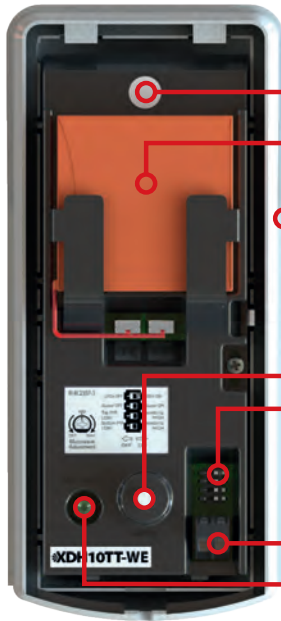

One-push-to-learn button

Batteries
Extra power pack 2 x 3V Lithium 4700mAh

Weatherproof housing
The housing of the XD detectors is made from 3mm thick polycarbonate plastic. This provides a robust barrier to the external environment, protecting the PCB and components from the effects of adverse weather conditions. The housing is made with a UV coating which stops the yellow aging of the plastic over time. The hood provides protection to snow, rain and other environmental disturbances.

Tamper button
DIP switches

Tamper
Terminal input for bracket

Microwave potentiometer
For altering microwave range: 0m to 15m (XDL) 0m to 10m (XDH)

See in action



Installation in 4 steps

- Step 1: Learn the detector and program the zone
- Step 2: Perform a signal strength test
- Step 3: Install the detector
- Step 4: Perform a walk test to check the correct installation

Tri-signal detection logic



Alarm activation

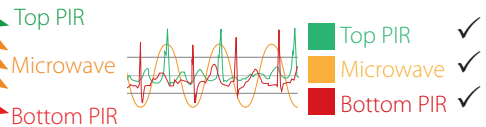

XDL detectors / L - Low mount installation - 1.2m

The optics of the XDL15TT-WE are designed to be installed at a low mounting height of 1.2m, giving a larger immunity to animals; 6 zones, 1 plane, and coverage of 14 degrees provides the best perimeter protection.

XDH detectors / H - High mount installation - 2.4m

The optics of the XDH10TT-WE detector are specifically designed for maximum protection to a height of 2.4m installation: 78 zones, 5 planes, and the 90 degree coverage provides complete volumetric coverage of the protected area.

XDL15TT-WE lens diagrams with the XD-LENS4

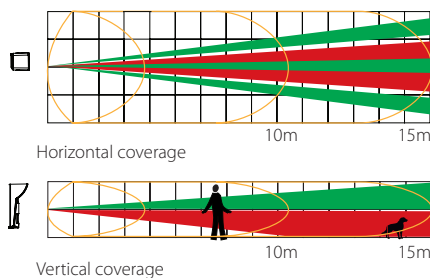

14°
6 Zones
1 Planes

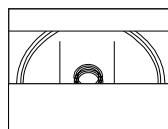

XDH10TT-WE lens diagrams with the XD-LENS5

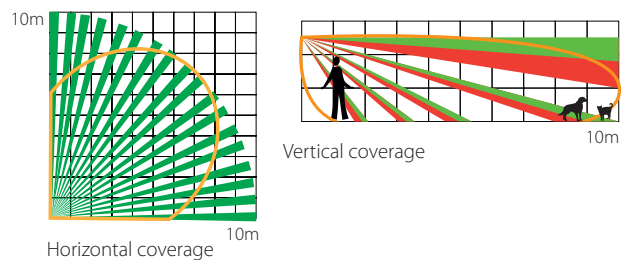

90°
78 Zones
5 Planes

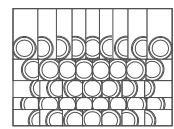

Wired external detectors

External tri-technology detectors



XDH10TT-AM



XDL15TT-AM

Optical and range features

	XD High Mount	XD Low Mount
Mounting height	2.4m	1.2m
Optimal installation height	2.4m	1.2m
Adjustable anti-masking (anti-spray) technology	✓	✓
Volumetric coverage	✓	✗
Curtain coverage with fixed mask	✗	✓
Maximum range	10m	15m

Key features

Anti-masking (anti-spray)	✓	✓
Anti-blocking technology	✓	✓
Animal immune	Up to 10kg	Up to 25kg
Triple detection logic: 2 x infrared + 1 x microwave	✓	✓
Automatic sensitivity	✓	✓
Independent Floating Threshold (IFT) technology	✓	✓
Digital temperature compensation	✓	✓
Separate indication: microwave, infrared, alarm	✓	✓
3 microwave frequencies to avoid interference	✓	✓
Integrated walk test buzzer	✓	✓
DEOL resistors on board	✓	✓
Tamper protection included	✓	✓

Electrical specifications

Relay output	3x SELV limit; 60DC 50mA (43.4AC at peak)
Internal tamper	12DC 50mA front and rear
Current consumption	23mA at rest/ 30mA in alarm
Relay	Alarm NC, Tamper, Mask/Fault, Alarm NO
Power	9-16DC, 13.8DC - 13.8DC nominal
RFI immunity from modulating wave (AM) and pulse modulated (PM) 80-2700MHz	25 V/m
RFI immunity from continuous wave (CW) 80-2700MHz	75 V/m
Microwave frequency	9.87, 9.90, 9.91 GHz
Direct light filter	>6500 Lux
Optics	Sealed optics
Geometric lens configuration	2D
Protection	IP55
Detection speed	0.25 - 3 m/s

Other details

Operating storage temperature	-30/+50 -40/+70
Weight	300g
Dimensions	118 x 77 x 84mm
Warranty	2 years

Accessories

2 adjustable masking lenses included	✓	✗
2 fixed masking grids to create curtain protection	✓	✗

Certifications

Electrical conformity	CE	CE
EN50131	Grade 3	Grade 3
Environmental class	IV	IV
 Pyronix	Self-certified	Self-certified

Wired coverage patterns and features

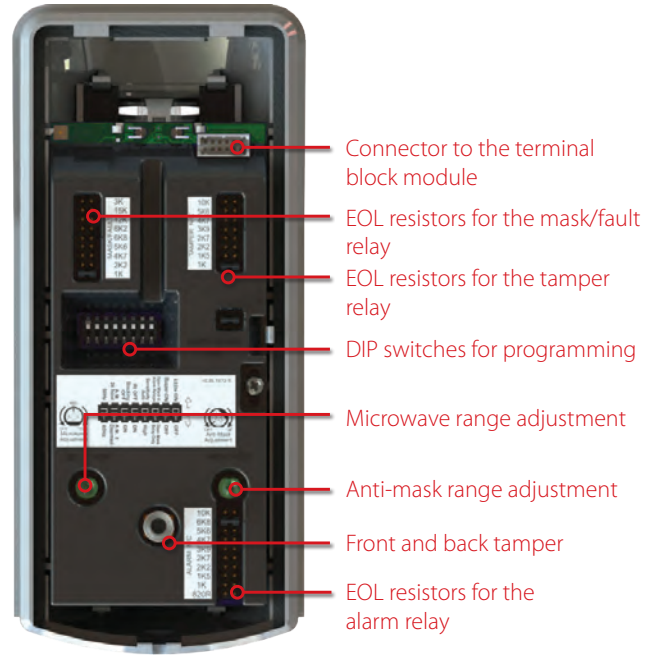
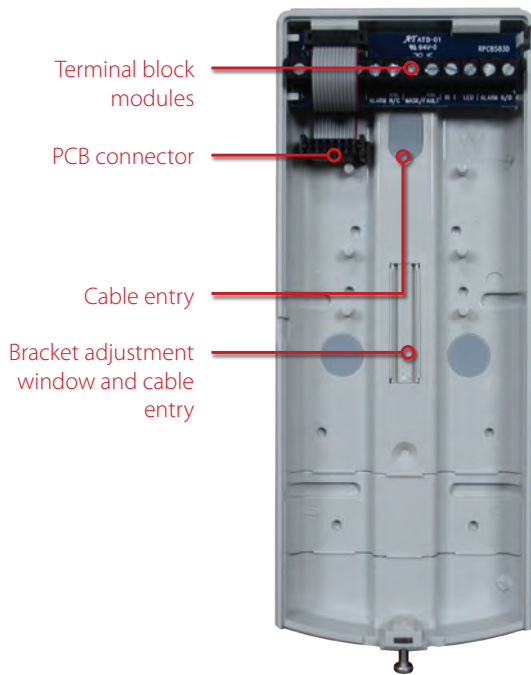

XDL detectors / L - Low mount installation - 1.2m

The optics of the XDL15TT-AM are designed to be installed at a low mounting height of 1.2m, which gives a larger immunity to animals; 6 zones, 1 plane, and coverage of 14 degrees provide the best perimeter protection.

XDH detectors / H - High mount installation - 2.4m

The optics of the XDH10TT-AM detector are specifically designed for maximum protection to a height of 2.4m installation: 78 zones, 5 planes, and the 90 degree coverage provide complete volumetric coverage of the protected area.



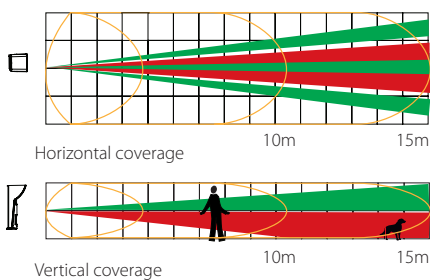

XDL15TT-AM Lens diagrams with the XD-LENS4

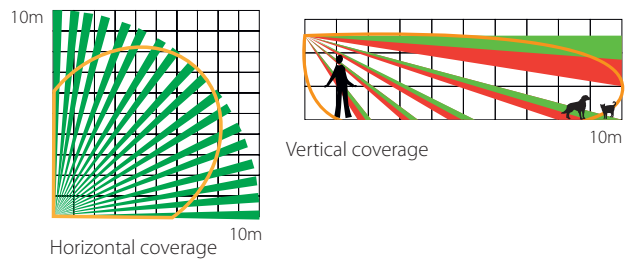

XDH10TT-AM Lens diagrams with the XD-LENS5



Accessories

	XD WALL BRACKET	Adjustable wall bracket +/- 45 degrees with anti-tamper protection. This allows for better volumetric coverage.		XD-LENS 5	Volumetric lens for the XDH. Installation 2.4m, 85 Degrees, 10m detection distance. (3pcs)
	XD ADAPTER	45 degree adapter for use with the XD-WALLBRACKET. This allows the XD detectors to be positioned at 90 degrees to the wall for protection of walls.		XD-LENS 4	Long range lens for the XDL series of detectors. 14 degree coverage, 6 zone edges, 1 plane. (3pcs)
	XD FIXED BRACKET	Wall bracket with rear tamper. This can be used to create 30m coverage protection of external walls.			





SOUNDERS

Wired and two-way wireless sounders

Provide the perfect visual and audible deterrent.

Easy to install, weather resistant and tamper proof, our external sounders come with a choice of coloured bases and customisable lids, as well as backlit and strobe options to deliver a highly effective aesthetically superior look day or night.

While our internal sounder delivers an extremely effective two tone frequency siren in the event of an alarm.



External sounder technology

The protection of a property starts with the exterior of the building and our backlit external sounders deliver the perfect visual deterrent to immediately discourage any potential intruder.

Weather resistant sounders with a low power, high performance piezo delivers a loud, audible deterrent with tamper protection.

Our pioneering industry first backlit external sirens provide a supreme visual deterrent.

Low power strobe

LED technology provides a visual indication when the alarm is activated.

Polycarbonate plastics

Offer a weather resistant housing with an elegant design.

Tamper protection

Ensuring the highest levels of security against accidental or malicious tampering with the system.

Low power Piezo

Low power piezo with high performance decibels provide a loud audible alarm, to ensure alarm activations are heard and acted upon.

Auto-levelling mechanism

Rotating guide holes and a built in spirit level facilitate the simple and easy positioning of the sounder during installation.

Engineer hold-off

The Sounder will disable when in 'Engineers Menu', which allows the installer to work without the fear of unwanted activations.

Customised sounders

A range of different coloured covers and bases can be chosen from, as well as screen printing corporate branding and details onto the cover, to provide year-round brand awareness.

Deltabell-WE

Being wireless, the can be fitted to the exterior of the property with no need to run wires to the control panel making it quicker and easier to fit with less mess.

Enforcer two-way wireless technology is designed to ensure high security protection for users, and simple and easy installation and maintenance for installers, utilising award winning features such as Signal Strength Indicator (SSI) and anti jamming.

128 bit encryption provides effective protection of signals being transmitted by the system and prevents code grabbing. This gives the wireless BUS a very high level of protection, ensuring peace of mind for the installer and users alike.

The high sensitivity receiver allows a wireless signal range of up to 1.6km in open space, eliminating the need for repeaters and reducing installation costs.

External sounder



DELABELL-WE

Key features

Sound output	98dB
Number of piezos	1
Strobe LED	✓
Engineer hold off	✓
Comfort LED	✓
Front and rear tamper protection	✓
3V / 5A lithium battery included	BATT-ES1
Signal Strength Indicators (SSI)	✓
Minimum battery life (years)	2
Warranty	2 years

Accessories

Polycarbonate base	✓
Cover sold separately	✓

Certifications

Electrical conformity	CE
EN50131	Grade 2
Environmental class	IV
	CA12.01330



DELABELL X

Key features

Sound output	106dB
Number of piezos	2
Strobe LED	✓
Comfort LED	✓
Optional backlight with DELTAX-LIGHT module	✓
Engineer hold off	✓
Rechargeable battery included	✓
Tamper protection included	✓
Warranty	2 years

Electrical specifications

Power	9-16V
Strobe duration	10mS
Frequency	1Hz
Current consumption	90mA at rest / 300mA in alarm
Electronic sounder	2

Certifications

Electrical conformity	CE
EN50131	Grade 2
Environmental class	IV
	Self-certified

Deltabell parts



Base



Module



Cover



Finished Deltabell

	DELTA-BDB	Deltabell base, blue		DELTA-CB	Deltabell cover, blue		DELTA/MOD-WE	Wireless Deltabell-WE module including the battery pack
	DELTA-BDR	Deltabell base, red		DELTA-CR	Deltabell cover, red		DELABELL X MODULE	Wired Deltabell X module with twin piezo sounder
	DELTA-BDW	Deltabell base, white		DELTA-CW	Deltabell cover, white		DELTAX-LIGHT	Backlight module for use with Deltabell X
	DELTA-BDBK	Deltabell base, black		DELTA-CBK	Deltabell cover, black			
	DELTA-BDA	Deltabell base, amber		DELTA-CY	Deltabell cover, yellow			
	DELTA-BDG	Deltabell base, green		DELTA-CC	Deltabell cover, chrome			

Accessories

	BATT-ES1	2x Lithium batteries. Used with Deltabell-WE, XD wireless detectors and Keypad, 3v, 5Ah
--	----------	---



Twin Alert wired internal sounder

The Twin Alert combines both a speaker and sounder in a single unit to eliminate the need for two separate products situated in different locations.

Audible notifications

The speaker element will mimic keypad tones and the sounds associated with the arming and disarming of a system enabling users to hear confirmation that it has armed correctly upon leaving the property. The volume of the tones can be adjusted to suit individual requirements.

Internal Sounder

The internal sounder will only activate on alarm and will override the pre-set speaker volume level to provide a siren output of 100 decibels at 1 metre. This high volume internal siren acts as a deterrent to intruders and will also alert any inhabitants.



TWIN ALERT

Strobe and sound features

Loudness	100dB @1m
Number of piezos	1
Engineer hold off	x
Tamper protection included	✓
For internal use	✓
Warranty	2 years

Certifications

Electrical conformity	CE
EN50131	Grade 2
Environmental class	II
 Pyronix	Self-certified

